

ST31

Track Loaders



**WACKER
NEUSON**
all it takes!



Vertical Lift Track Loader

The ST31 offers the power and torque needed for any jobsite. This unit delivers 3,100 pounds of rated operating capacity at 50% and is a class leader with lift height over 125 inches. The machine is equipped with a 74 hp turbo-charged Kohler Tier 4 Final engine offering class leading engine torque. Mechanical Hand-Foot and Selectable EH controls ensures operators with any control preference can efficiently operate the machine. With generous door width and height, visibility of the attachment and the surroundings is superior to the competition.

- With a top speed of nearly 10 MPH, travel time is reduced giving the operator more time throughout the day to get more tasks completed.
- Spacious extended cab maximizes room and comfort for the operator to move inside the cab.
- Quick and easy service access from the forward tilting cab and the arrangement of internal components makes it easy to maintain the machine.
- Class leading track-on-ground of 57.2" decreases ground pressure while increasing digging performance.
- Optional high flow hydraulics increase the range of usable attachments improving efficiency and productivity.

ST31 Technical specifications

ST31

Operating data

Height top of ROPS	83 in
Overall length w/ bucket	136.6 in
Overall length w/o bucket	106.6 in
Height Hinge Pin Max	125.5 in
Operating weight	8,095 lb
Rated Operating Capacity ROC 50%	3,100 lb
Rated Operating Capacity ROC 35%	2,170 lb
Dump reach	36 in
Length of track on ground	57.2 in
Dump height max. at max height	97.2 in
Angle of departure	30.7 °
Tipping angle (bucket dump) w/ bucket at max height	42 °
Ground clearance	9.1 in
Breakout force max. - Bucket	5,300 lbf
Breakout force max. - Boom	5,000 lbf
Width	67.1 in
Width Track	12.6 in

Engine / Motor

Engine / Motor manufacturer	Kohler
Engine / Motor	KDI 2504 TCR
Engine performance	74 hp
Displacement	151.5 in ³
RPM / speed	2,750 rpm
Battery	950 CCA
Fuel tank capacity	30 US gal

Hydraulic system

Auxiliary Hydraulics- Standard Flow	20 US gpm
Auxiliary Hydraulics- High Flow	30 US gpm
Pressure aux. relief	3,500 psi
Hydraulic oil tank	2.9 US gal

Power transmission

Travel speed low	7 mph
Travel speed high	10 mph

ST31 Dimensions

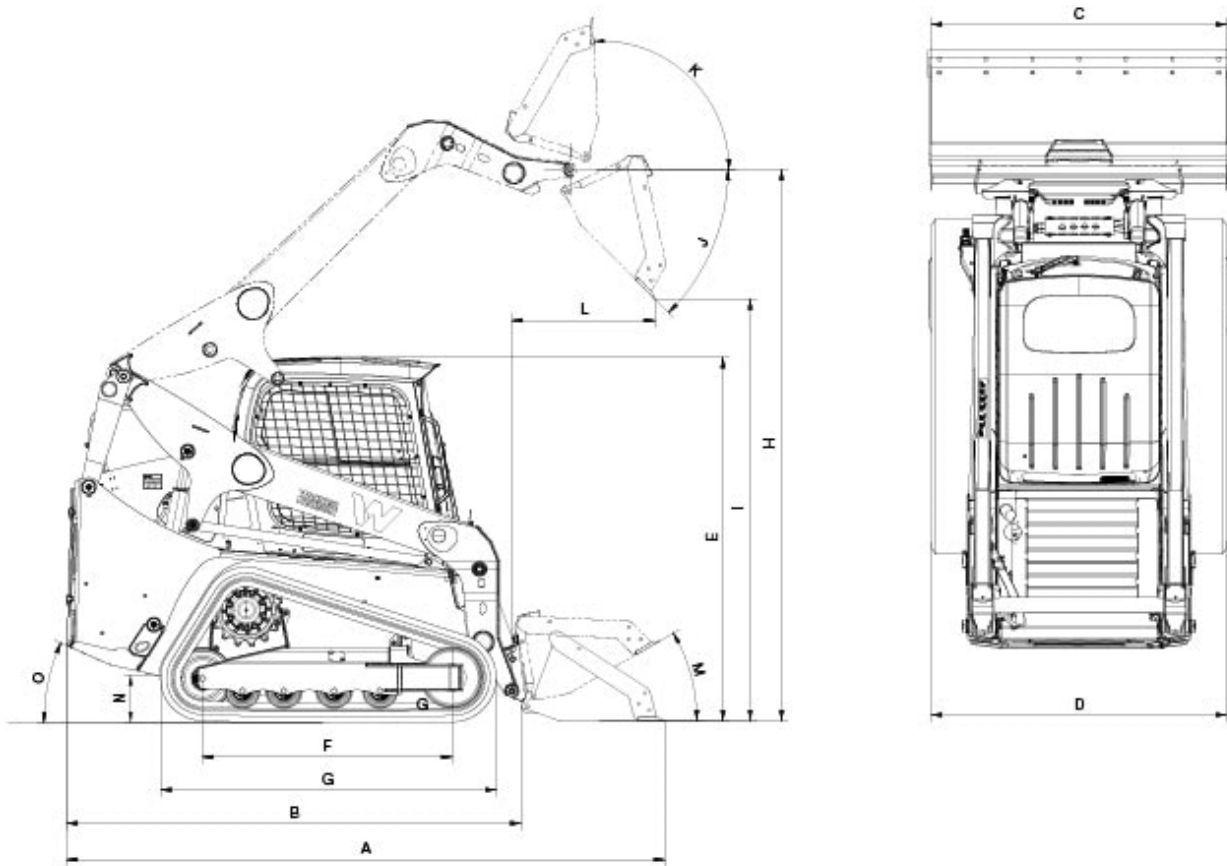

		ST31
A	Overall length with bucket	136.1 in
B	Overall length without bucket	106.6 in
D	Overall width without bucket (Standard Tracks)	67.1 in
	Overall width without bucket (Wide Tracks)	70.3 in
E	Overall height	83 in
G	Track length	57.2 in
H	Hinge pin height	126 in
I	Dump height max.	97.2 in
J	Dump angle	42 °
K	Bucket rollback at max. stroke height	30 °
L	Dump reach	39.2 in
M	Bucket rollback at ground level	30 °
N	Ground clearance	9.1 in
O	Angle of departure	30.7 °

Please note: that product availability can vary from country to country. It is possible that information / products may not be available in your country. More detailed information on engine power can be found in the operator's manual; the stated power may vary due to specific operating conditions. Subject to alterations and errors excepted. Applicable also to illustrations.

Copyright © 2020 Wacker Neuson SE.